

innowater
monitor
user manual

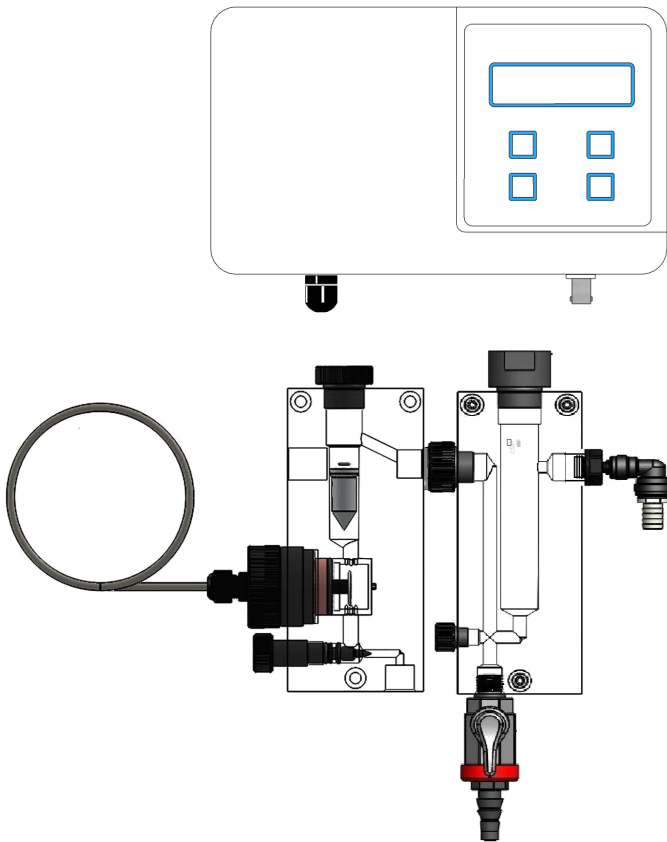



Table of contents

	Page
1 Warnings	2
2 Packaging contents	3
3 System description	4
3.1 Physical description.....	4
3.2 Operation principles.....	6
4 Installation	9
5 Control Unit	11
5.1 Chlorine function.....	12
5.1.1 4-20mA Output.....	12
5.1.2 Relay Output.....	14
5.1.3 Radio 1 Output (0-100%).....	17
5.1.4 Radio 2 Output (PWM)	18
5.1.5 Slope Calibration.....	19
5.1.6 Zero point Calibration.....	20
5.1.7 Factory Calibration.....	21
5.1.8 Dosing time alarm.....	21
5.2 pH Function.....	23
5.2.1 a 5.2.4 pH Outputs.....	23
5.2.5 pH4 Calibration.....	24
5.2.6 pH7 Calibration.....	25
5.2.7 pH Factory Calibration.....	25
5.2.8 Dosing time alarm.....	25
5.3 Initial Dosing Delay.....	27
5.4 Flow Sensor.....	27
5.5 LCD Contrast.....	27
5.6 Radio Transmission Channel.....	28
5.7 Modbus.....	29
6. Wireless Pumps	30
7. Maintenance	34
7.1 Filter.....	34
7.2 Probes.....	34
7.3 Chlorine Probe Replacement.....	34
7.4 Priming the pumps.....	34
8. Technical Characteristics	35

1. WARNINGS



The innowater monitor controller enables continuous measurement of swimming pool water parameters through bypass probes and the controlling of acid injection pumps or chlorine generators in order to maintain levels automatically within a pre-set range. However, both the pH and chlorine probes are subject to wear and tear, their response deteriorates over time and they are a delicate component that can be easily damaged. Like any other device, the electronic measuring system may experience a fault that causes an incorrect reading of parameters. For this reason, a **MANUAL CHECK** of the parameters should be performed periodically by approved manual means in order to ensure that their level remains within regulatory limits.

INNOWATER TRATAMIENTOS INTERGRALES DEL AGUA S.L. accepts no liability for possible material and/or personal damage caused by the excessive or insufficient injection of acid or oxidant or due to the handling of chemical products.

WARNING! Acid is corrosive and can seriously damage the eyes and skin. Oxidants (hypochlorite) are harmful and can seriously damage the eyes, skin and respiratory tract. By reacting with other compounds, they can produce highly dangerous poisonous gases. Wear appropriate protective equipment when handling chemical containers or dosing equipment.



The appliance must be connected to a suitable earth conductor and protected by a 30-mA residual-current device.

Never open the appliance when it is connected to electricity. Danger: 230 VAC voltage.

Any inspection or handling inside the device must be carried out by a qualified professional.

2. PACKAGING CONTENTS

The packaging contains the following items:

1 Wall panel

- Control unit
- Probe holder
- Filter
- Outputs connector

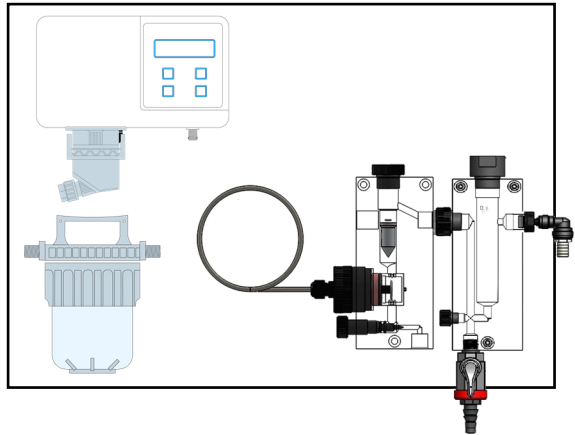

2 Open chlorine probe (already installed in the probe holder)

3 pH probe

4 pH4 and pH7 calibration solutions

5 Inductive flow sensor (already installed in probe holder)

6 Innower open probe Monitor manual

7 Hydraulic fittings

- Shut-off valves x2
- 6x8 Rigid PP tube
- 6x8 Flexible PVC tube

3. SYSTEM DESCRIPTION

The innowater monitor system enables continuous measurement of pH and chlorine concentration in swimming pools and the controlling of any dosing device, such as an acid or hypochlorite pump, or production device, such as a salt chlorinator, in order to maintain chlorine and pH levels automatically within a pre-set range. Radio frequency monitoring of the dosing devices facilitates installation and allows the acid or oxidant to be separated from the electronic measuring equipment.

3.1 Physical description

Panel

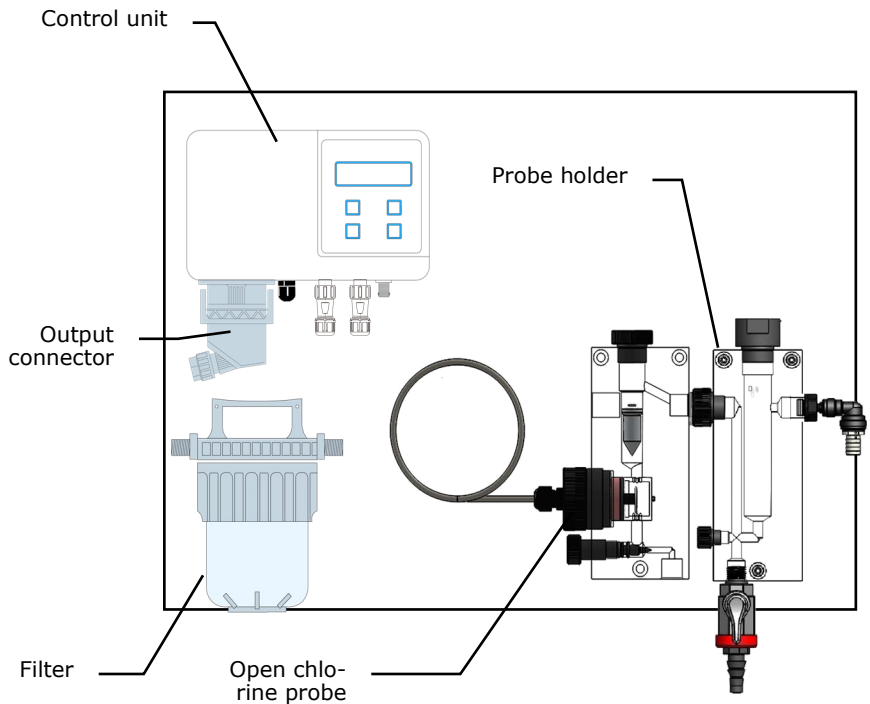

Probe holder

Methacrylate prober holder with flow sensor and flow regulation. It supplies a constant flow to the probes and allows for an optimal visual probe inspection.

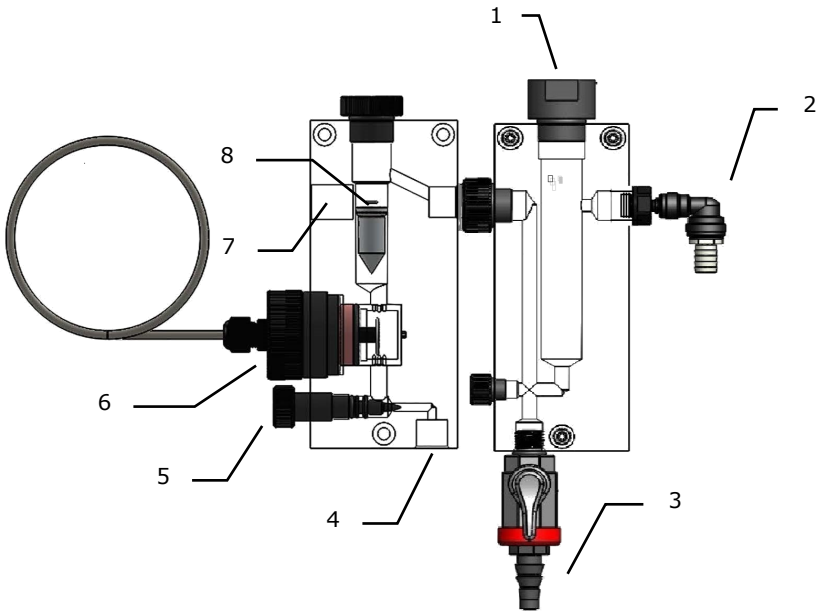

1 pH probe housing

2 Water flow outlet

3 Sample outlet

4 Water Flow inlet

5 Flow regulation screw

6 Open chlorine sensor

7 inductive flow sensor housing

8 Flow sensor weight

Control unit

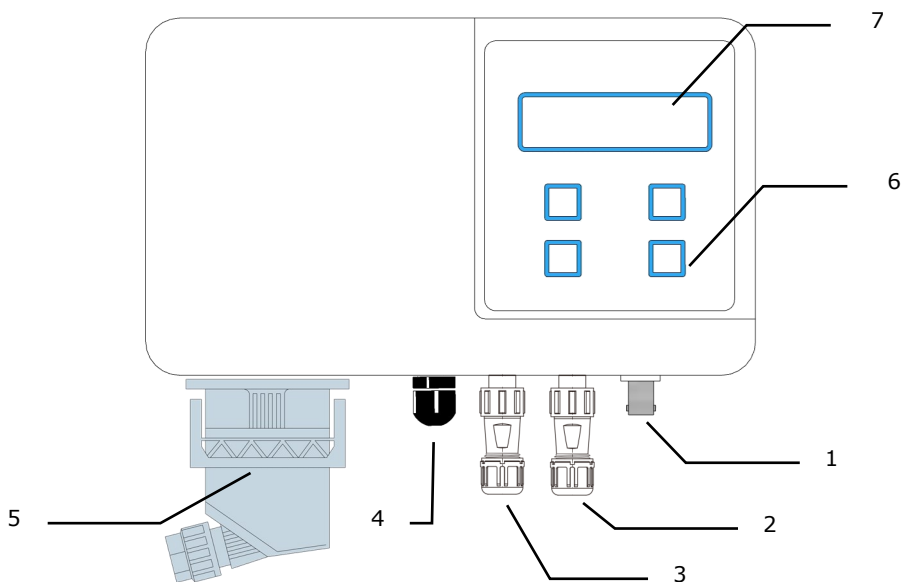

- 1 pH probe BNC connector
- 2 Flow sensor connector
- 3 Chlorine sensor connector
- 4 Power Supply cable

- 5 Outputs connector
- 6 Keyboard
- 7 LCD display

Outputs connector

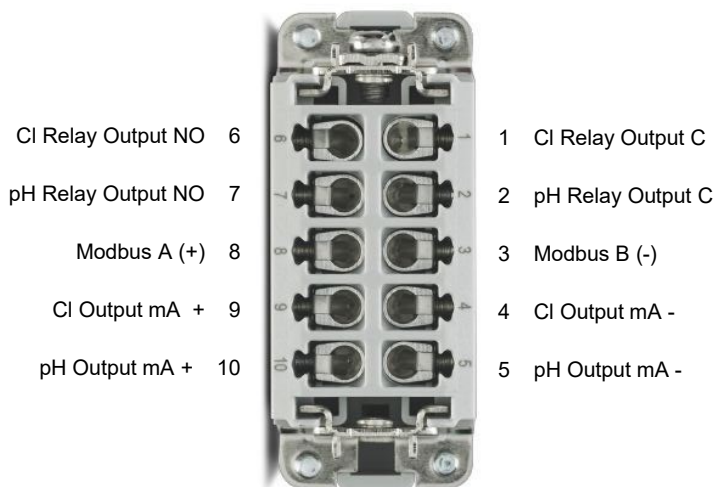

3.2 Operation principles.

The innowater monitor provides a real-time reading of water parameters through its chlorine and pH probes. Each probe is connected with four control outputs that can act on different dosing devices to maintain the chlorine and pH values within a pre-established range. The programming of each output is independent and these can act simultaneously, enabling control of up to eight different devices. The radio outputs provide wireless control of innowater devices, which facilitates the installation and separation of acid or oxidant tanks from electronic measuring equipment.

Control outputs:

1. 4-20 mA analogue outputs

Linear control analogue outputs via two-wire 4-20 mA current loop. They provide an isolated voltage of 24 VDC max. and 1 W. The coding is:

$$\begin{aligned}4 \text{ mA} &= 0\% \\20 \text{ mA} &= 100\%\end{aligned}$$

See point 4.7 on the outputs' connection. See point 5.1.1. on its programming.

2. Relay outputs

Programmable volt-free contact outputs. They can be programmed proportionally, with a 100-second duty cycle, or in on-off mode.



The contact supports 230 VAC and 2 A max. Do not connect inductive loads directly.

See point 4.8 on the connection and point 5.1.2 on its programming.

3. Radio 1 Outputs

0%—100% control outputs for wireless linear control innowater devices (chlorinators, peristaltic pumps). See point 4.9 on the connection and points 5.1.3 and 5.8 on its programming and set-up.

4. Radio 2 Outputs

Proportional on-off control outputs by duty cycle of 100 seconds (PWM) for innowater wireless ON/OFF control devices (pulse pumps). To force the ON state of the Radio 2 outputs and prime for example, a wireless pump, press the up arrow (Ch pump) or the down arrow (pH pump) for two seconds from the main screen. Check points **5.1.4 and 5.2.4 Radio 2 outputs** and point **5.8 Radio channel** to ascertain the outputs' operation.

Probe holder and filter

The probes are housed in a methacrylate probe holder fitted on the panel through which a small flow of water to be sampled is continuously circulated. Before entering the probe holder, the water passes through a filter, also integrated in the panel, which ensures the filtering required by the probes.

The sample flow can be regulated with the aid of a pitch screw and a weight whose height indicates the size of the flow.



It is important that the flow rate, indicated by the position of the weight, is constant as the probe response is flow rate dependent.

A proximity sensor detects at all times if the weight reaches a minimum height and indicates this by lighting its LED. In case of insufficient flow detection, and if flow detection has been activated (see 5.7 Flow Detector), probe and dosing readings are interrupted (all outputs OFF).

Probes

The probes installed in the probe holder provide real-time chlorine and pH readings for the water. These levels are displayed on the main screen. In order to obtain accurate readings of the water parameters, the probes must be calibrated before their first use and regularly afterwards. This is because different probes can have different responses and the response of the same probe inevitably varies over time.

Open chlorine sensor

Open chlorine cells measure free chlorine. They are easy to use and have lower installation and maintenance requirements than membrane probes. Although they do not measure organic chlorine (chlorine combined with cyanuric), they can always work with stabilizer provided as long as the concentration is within recommended limits (< 20 mg/l) and the sensor is calibrated whenever the stabilizer concentration changes.

Always bear in mind that the response of the probe is highly dependent on flow rate, pH, temperature and conductivity. Therefore, **whenever the conditions change, a new calibration must be performed.** Do not interrupt the power supply as the probe will polarize and a new time of depolarization and a new calibration will be needed.

Before the first calibration, the sensor requires a 4-hour period in circulating chlorinated water in order to condition the electrode surface. Always calibrate the sensor slope (5.1.4 Slope calibration) with the highest possible chlorine concentration within its range (0.0–5.0 ppm). Take a water sample from the probe holder and use a photometric medium (DPD1). For this, the probe holder has a sample output with a shut-off valve. Remember that **sensor response varies with flow rate** and this should be adjusted before calibrating.

For zero-point calibration (5.1.5 Zero-point calibration), install an activated carbon filter in the filter holder and circulate the water to be sampled for at least 10 minutes through the probe holder. **Never use distilled water.**

pH Probe

Calibration of the pH probes involves using the two calibration solutions supplied (pH4 and pH7). The response of the probe to the two known pH solutions must be recorded in order to calculate the pH of any other solution: in this case, the flow that passes through the probe holder. Use 5.2.3 pH4 Calibration and 5.2.4 pH7 Calibration functions.

4. INSTALLATION



Before installing or maintaining the system, disconnect power to all equipment components.

Installation and maintenance must be carried out by authorized qualified personnel.

4.1 Control panel

The control unit, probe holder and filter are already mounted on a panel in order to facilitate installation. Choose the installation site, taking into account that the water to be sampled must be directed to the panel and then back to the drain or a tank. Choose a location away from acid or oxidant tanks. Hang the panel on the wall using the upper brackets and make sure that it is stable and that the lower stops rest on the wall.

4.2 pH probe

Install the pH probe in its housing on the probe holder and connect its cable to the control unit BNC connector.

4.3 Chlorine probe

The chlorine probe is already mounted in the probe. If you need to replace it, see point **7.3 Chlorine probe replacement**.

4.4 Hydraulic panel connection

Place the intake for the probe holder preferably before the swimming pool filter **and always before the chlorinator cell or any injection point for products or water treatment equipment**. The outflow from the probe holder must be connected to a point at atmospheric pressure such as a drain or surge tank. If this is not possible, you connect the outflow to the pump suction. Connect the water inflow to the panel filter by inserting the supplied shut-off valve. Connect the return tube to the probe holder output connector. You can also install the supplied valve on the return if you wish.

Adjust the probe holder waterflow using the adjustment screw until the weight reaches the mark on the probe holder. **The response of the chlorine probes is proportional to the flow rate; therefore, you must always maintain the same flow rate in the probe holder.**

4.5 Panel power supply

Once all the panel features have been installed, connect the power cable to a permanent 230 VAC socket provided with a **protective earth conductor** and a **30-mA residual-current device**.



Once in operation, do not interrupt the panel power supply because the chlorine probe will polarize and require time to depolarize before measuring correctly again. If the power has been disconnected, calibration should be carried out after at least 6 hours.

4.6 Wireless pumps

See chapter **6 WIRELESS PUMPS**

4.7 4-20mA Outputs

Disconnect the outputs connector (5) by pushing its latch bar up. Once separated from the board remove the 4 screws and remove the contact carrier. Connect the positive wires (marked as 1 if they are Innwater devices) of the equipment to be controlled in positions 4 and 5 of the connector (see figure page 6) and the negative wires (marked as 2 if they are Innwater devices) in positions 9 and 10 respectively.

The 4-20mA outputs provide an isolated voltage of 24VDC max. and 1 W. See points 5.3.2 to ascertain the outputs' operation.

4.8 Relay outputs

Disconnect the outputs connector (5), pushing its latch bar up. Once separated from the board remove the 4 screws and remove the contact carrier. Connect the relay outputs in positions 1, 6, 2 and 7, respectively (see figure page 6).

The relay outputs do not provide voltage. Their contacts support 230VAC and 2 A max. Do not connect inductive loads directly. See point 5.3.2 to ascertain the relay output operation.

4.9 Radio 1 and Radio 2 outputs

The radio outputs do not require a connection. As soon as the controller and pump are connected to the network, communication will be established. See points **5.1.3**, **5.1.4**, **5.2.3** and **5.2.4** to ascertain the outputs' operation. See point **5.8 Radio channel** to connect a pump to the chlorine or pH output.

5. CONTROL UNIT

Start-up and main screen

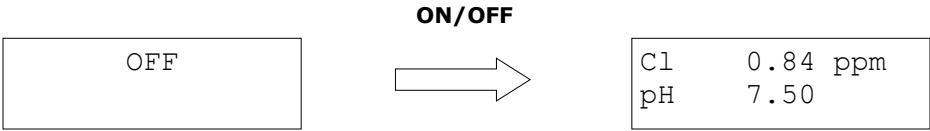

Once all the panel features have been installed, press the **ON/OFF (MENU)** key for two seconds to turn on the controller. The main screen (right) will be displayed on the screen, showing the current chlorine and pH measurements.

Priming wireless pumps (Radio 2 Outputs)

To force the ON state of the Radio 2 outputs (in order to prime a pulse pump, for example), press the up arrow (Ch Radio 2) or the down arrow (pH Radio 2) for 2 seconds from the main screen:

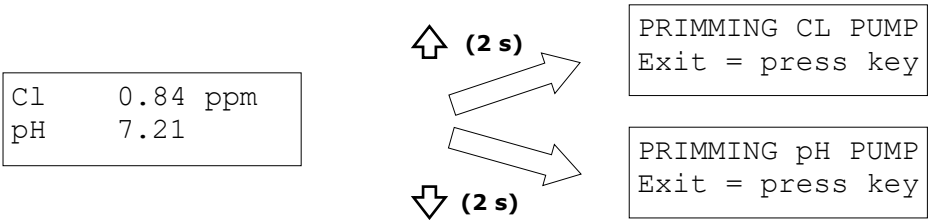

The Radio 2 output (Ch or pH) will send the ON command while the screen is displayed regardless of the programming and readings of the probes.

Access to function menus

Press the **MENU** key from the main screen and then scroll with the arrows through the different functions. Press OK to enter the desired function and access its sub-menus.

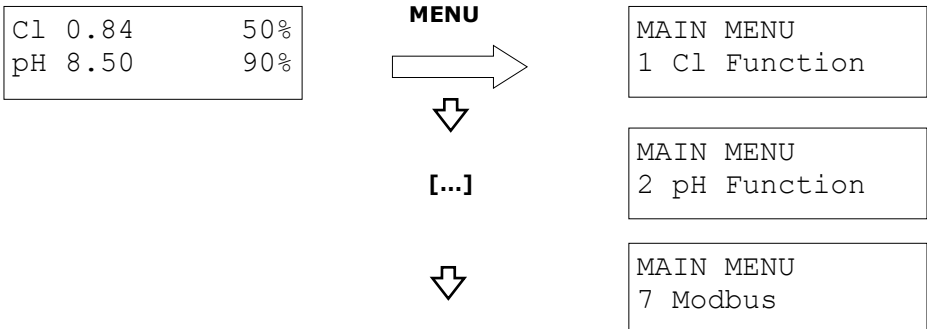

5.1 CHLORINE FUNCTION

All the functions and settings related to chlorine measurement are found within the **MAIN MENU - 1 Chlorine function** and various sub-menus.

Cl	0.84	50%
pH	8.50	90%

MENU



MAIN MENU
1 Cl Function

5.1.1 Chlorine function - 4-20 mA Output

MAIN MENU
1 Cl Function

OK

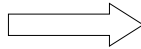

Cl Function
1 4-20mA Output

Setpoints

Cl Function
1 4-20mA Output

OK

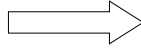

Cl 4-20mA Output
1 Set points



OK

Cl	<	0.20	80%
Cl	=	1.00	20%

The 2-wire 4-20mA analogue outputs represent the percentage of dosing in mA using a linear relationship:

4 mA = 0%

20 mA = 100%

The percentage of dosage at each instant is calculated from the two programmable setpoints shown on the lower screen. The calculation (blue trace) is as follows:

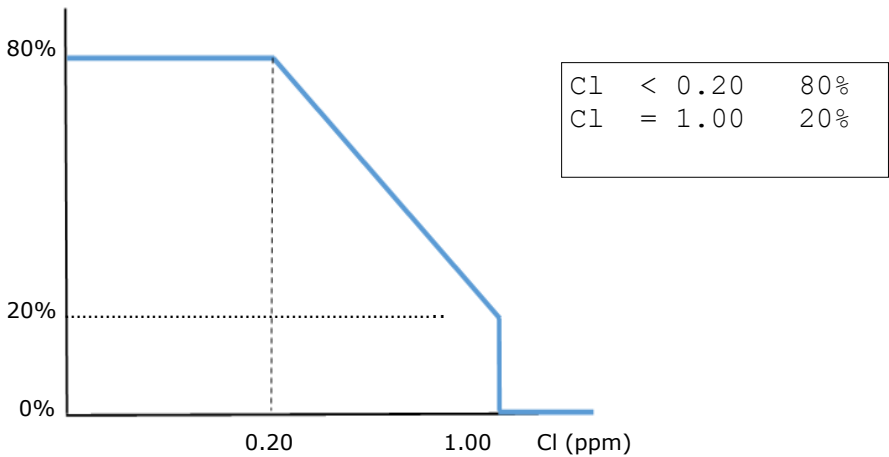

- When the chlorine concentration is below the lower setpoint (0.20 ppm in the figure), the output will be constant and equal to the dosage defined below that point: 80% in the figure (16.8 mA).

- When the chlorine concentration is between the two points, the output will be a proportional value defined by both percentages. For example, in the case of the figure, if the chlorine concentration is 0.60 ppm, the output will be equal to 50% (12 mA).

- When the chlorine concentration is above the upper setpoint (1.00 ppm in the figure), the output will be maintained at 0% (4 mA).

You can set both points and choose the dosage percentage for each of them. To do this, position the cursor using the **MENU** key on the parameter you want to modify and use the arrows to change its level. Press **OK** to save the data and exit the sub-menu.

By establishing the setpoints, you will be defining at the same time the necessary dosage volume and the response delay to the swimming pool dosage, both of which depend on the size of the swimming pool. For example, if the swimming pool has a high volume, you should choose both high dosage percentages. The delay of the chlorine measurement of your swimming pool can be determined when setting the B setpoint by cutting the dosage before reaching the desired value. For example, to obtain a chlorine concentration of 1.00 ppm and avoid overdosing, you can set the dosing cut-off somewhat lower:

B: Ch 0.90 0%

As each swimming pool requires varying amounts of oxidant and reacts to differing degrees to the dosage, at the beginning at least, you may need to correct the setpoints several times.

Output state

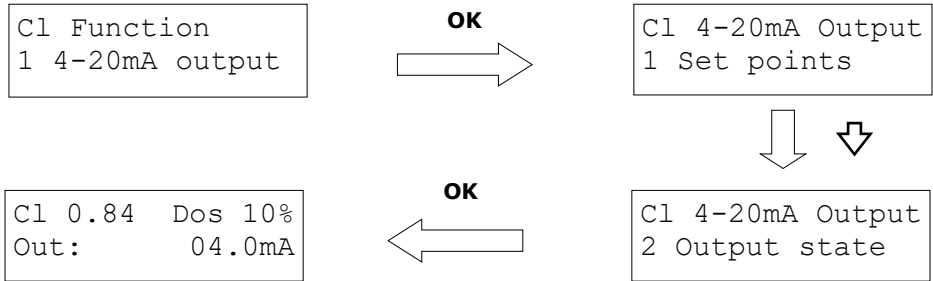

This screen displays information on the current status of the 4-20 mA chlorine output. It displays: the current chlorine measurement, the dosage calculated for this output (see previous point) and the current output level in mA. Note that if there is any cause (delay on, no flow), the output may reflect 0% (3.75 mA) even if the calculated dosage is not 0%.

5.1.2 Chlorine function - Relay output

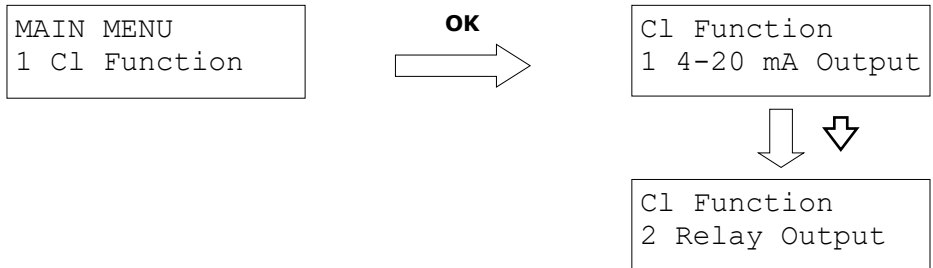

Relay Set-up

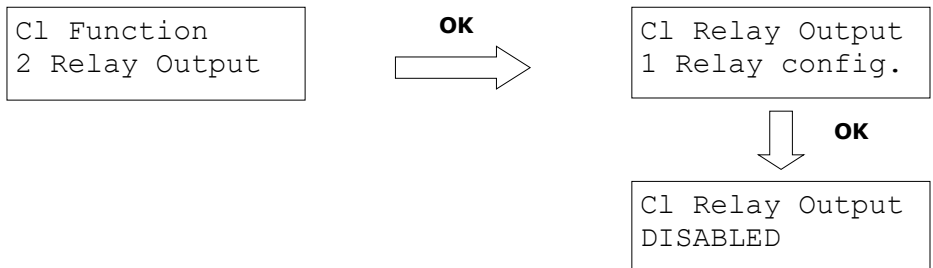

When you enter the relay set-up menu, choose the mode using the arrows:



Cl Relay Output
DISABLED

Cl Relay Output
ON / OFF

Cl Relay Output
PROPORTIONAL

Once in the preferred mode, press **OK** to select the mode and enter the respective set-up menu or press **MENU** to exit.

Off mode

Cl Relay Output
DISABLED

OK

Choose this mode if you are not going to use the output. When you press **OK**, you can select the mode and return to the previous menu.

ON/OFF Mode

Cl Relay Output
ON / OFF

OK

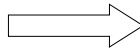

Cl < 1.00 ON
Cl > 1.50 OFF

In the ON/OFF mode, the relay output will remain ON (contact closed) whenever the chlorine measurement is below the lower setpoint (1.00 ppm in the figure) and will remain OFF (contact open) whenever it is above the upper setpoint (1.50 ppm in the figure). If the chlorine concentration is between the two points (1.00 – 1.50 ppm), the output will not change and will remain in its previous state (hysteresis).

Choose the value of the setpoint with the help of the arrows and change from one point to another with the **MENU** key. Press **OK** to save and exit.

Proportional mode

Cl Relay Output
PROPORTIONAL

OK

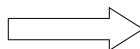

Cl < 0.20 50%
Cl = 1.00 0%

The operation of the setpoints is analogous to that of the 4-20 mA chlorine output (see **5.1.1**). In the relay output, the calculated dosage percentage will be reflected by activating the contact in duty cycles of 100 s. During each cycle, the output will remain ON (closed contact) for a number of seconds equal to the dosage percentage. For example, if the calculated dosage is 20%,

the contact will remain closed for the first 20 seconds of the cycle and open for the remaining 80 seconds. In the status screen of this output (see the next point), you can monitor its operation.



DO NOT use the relay output in proportional mode to control a salt water chlorinator. To control a salt water chlorinator with the relay output, use only the ON/OFF mode.

Relay output state

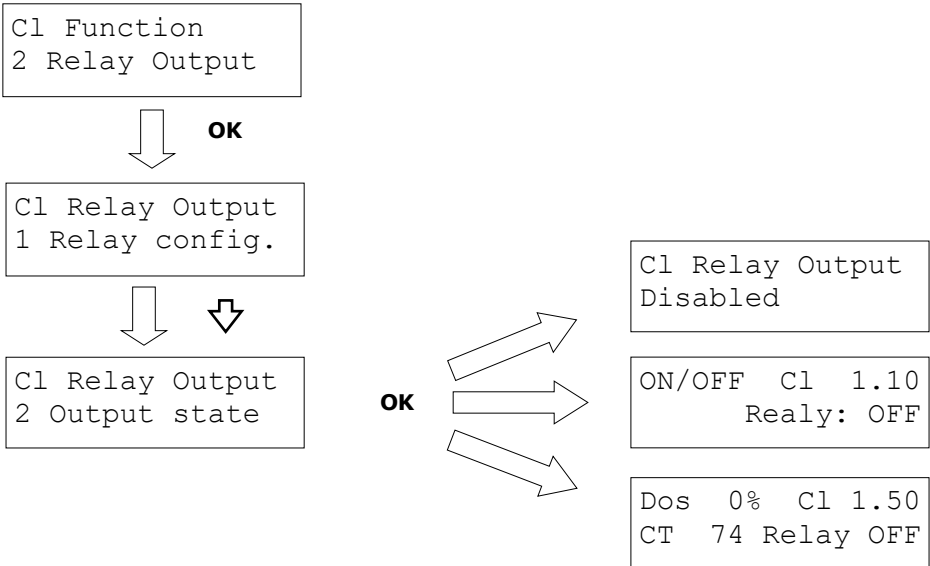

This screen displays the current status of the chlorine relay output. Depending on the selected mode, the following information can be read:

- In *OFF* mode, only "Ch relay output OFF is displayed.
- In *ON/OFF* mode, the current chlorine reading and the relay status are displayed.
- In *PROPORTIONAL* mode, the current dosage, the current chlorine reading, the course of the relay duty cycle, DC, and the current state of the relay are displayed.

If there is any cause (delay activated, no flow), the output may display Relay OFF even though the dosage is not 0%.

5.1.3 Chlorine function - Radio 1 Output (0-100%)

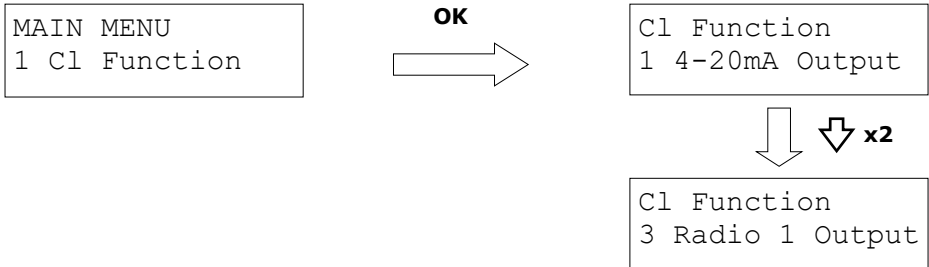

The radio 1 output enables an Innowater linear control wireless device (0 – 100%), such as a chlorinator or variable speed peristaltic pump, to be controlled.

Setpoints

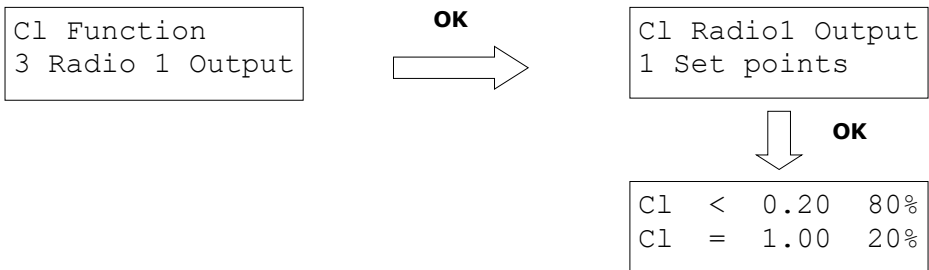

The operation of the setpoints is analogous to that of the 4-20 mA chlorine output (see **5.1.1**). In this case, a command with the linear control information (0–100%) is transmitted continuously via radio.

Output status

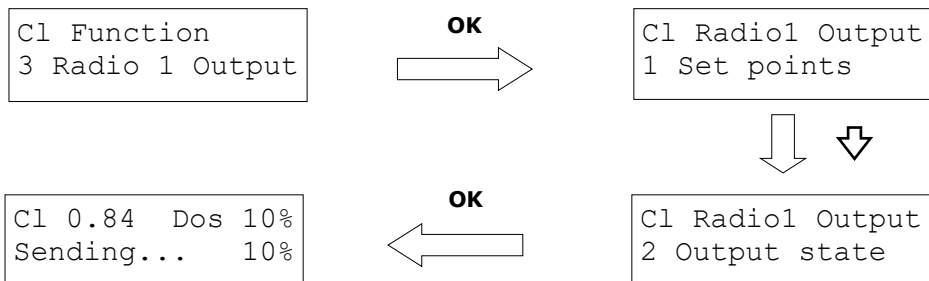

This screen shows the current chlorine measurement, the calculated dosage percentage, and the control command that is being transmitted. NB. If there is any cause (delay activated, no flow), the transmitted command will be 0% even if the dosage is not 0%.

5.1.4 Chlorine function - Radio 2 Output (ON/OFF)

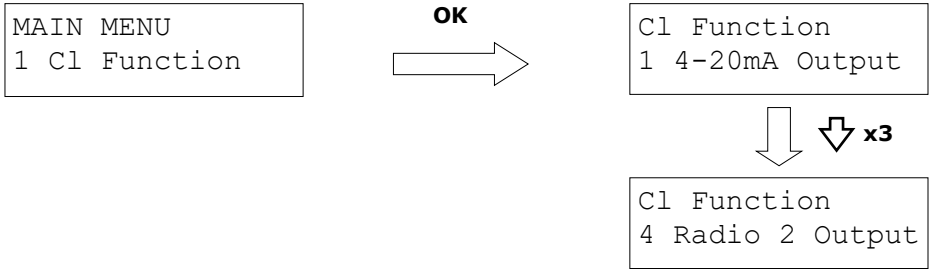

The radio 2 output enables the ON/OFF function on an Innwater wireless device, such as a wireless pulse pump, to be controlled using a 100 s duty cycle (PWM).

Setpoints

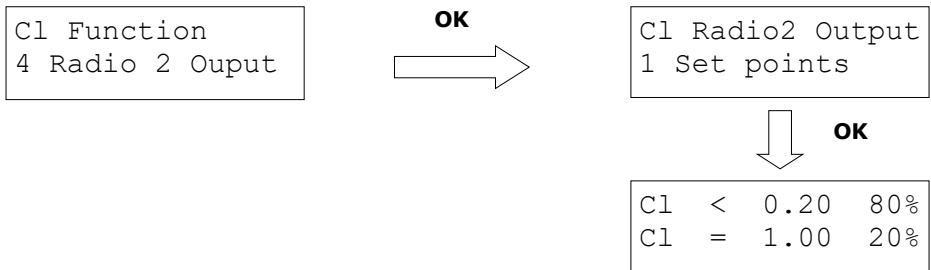

The operation of the setpoints is analogous to that of the 4-20 mA chlorine output (see **5.1.1**). In this case, a command with the binary control information (ON/OFF) is transmitted continuously via radio. The calculated dosage percentage will be materialized by working cycles of 100 s. During each cycle, the transmitted command will be ON for a number of seconds equal to the dosage percentage. For example, if the calculated dosage is 20%, the command will be ON for the first 20 seconds of the cycle and OFF for the remaining 80 seconds. You can monitor its operation on the status screen of this output (see the next point),

Output status

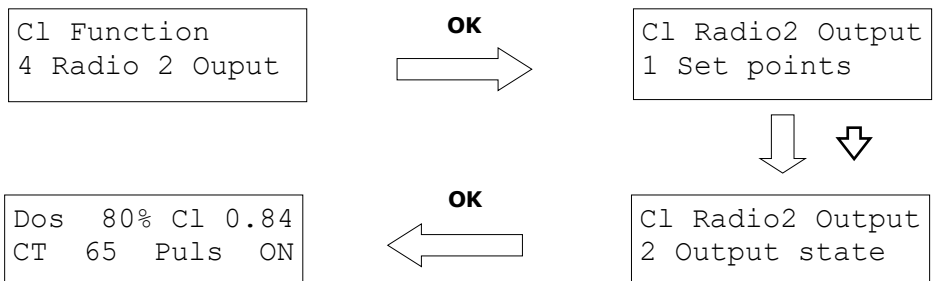

This screen shows the current chlorine measurement, the calculated dosage percentage, the course of the duty cycle (DC) and the command being transmitted (Puls). NB. If there is any cause (delay activated, no flow), the transmitted command might be *Puls OFF* even though the dosage is not 0%.

5.1.5 Chlorine Function – Slope Calibration

Slope calibration consists of recording the response of the probe with a certain amount of chlorine in the water. The higher the chlorine concentration, the more accurate the calibration will be. See section 3.2 Chlorine probe open.

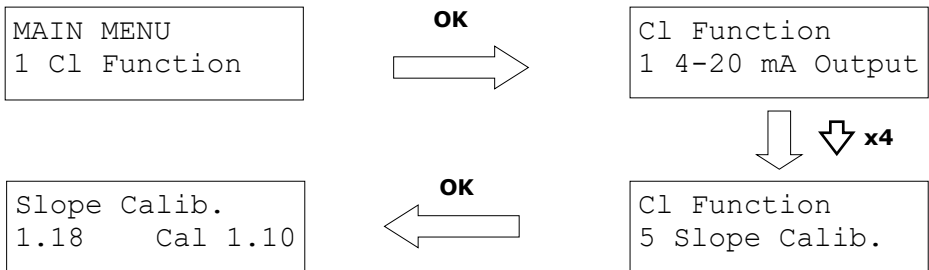

The value on the left shows the current reading of the chlorine concentration measured by the probe. The amount to the right of *Cal* indicates the actual level of the concentration. Measure the actual concentration via the photometric method (DPD1), taking a sample from the probe holder and adjusting the actual level with the help of the **MENU** key and the arrows. Click **OK** to accept.

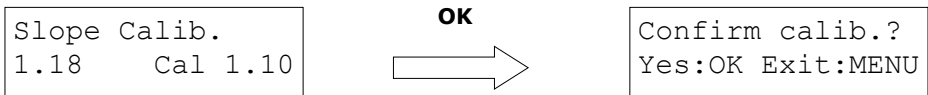

Click **OK** to save the calibration or **MENU** to exit without saving the calibration.

If you click **OK**, one of the following two screens will appear momentarily:



The screen on the left indicates that the calibration amounts entered are consistent and the calibration has been saved.

The screen on the right indicates that the amounts entered are too far from the expected amounts and that calibration has not taken place. This may be due to introducing an excessively high or low probe response or to undertaking a calibration too close to the zero point (see next

section). In that case, ensure the zero-point calibration is correct and move away from it in order to calibrate the slope. The minimum distance from the zero point is approximately 0.25 ppm.

5.1.6 Chlorine Function – Zero-point calibration

Zero-point calibration consists of recording the response of the probe in the absence of chlorine. See section 3.2. Chlorine probe open.

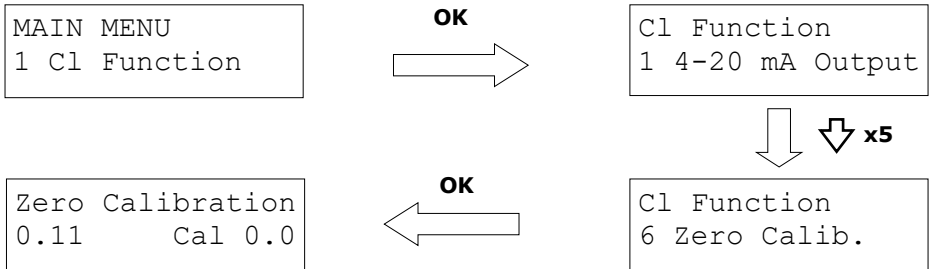

The amount on the left shows the current reading of the chlorine concentration measured by the probe. Run chlorine-free water through the probe holder for at least 10 minutes. Use an activated carbon filter if the water contains some chlorine. Never use distilled water because it will disable the probe. Wait for the reading to stabilize and press **OK**.

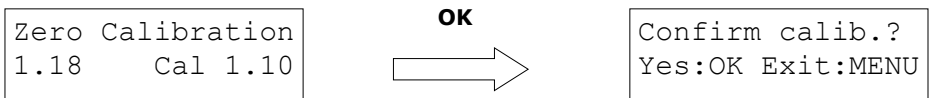

Click **OK** to save the calibration or **MENU** to exit without saving the calibration.

If you click **OK**, one of the following two screens will appear momentarily:

ZERO CALIBRACION
OK

ZERO CALIBRACION
ERROR

The screen on the left indicates that the entered calibration amounts are consistent and the calibration has been saved.

The screen on the right indicates that the amounts entered are too far from the expected amounts and that calibration has not taken place. This is usually due to trying to record an excessively high probe response for the zero point. Make sure the sample does not contain chlorine and that enough time has elapsed.

5.1.7 Chlorine Function – Factory Calibration

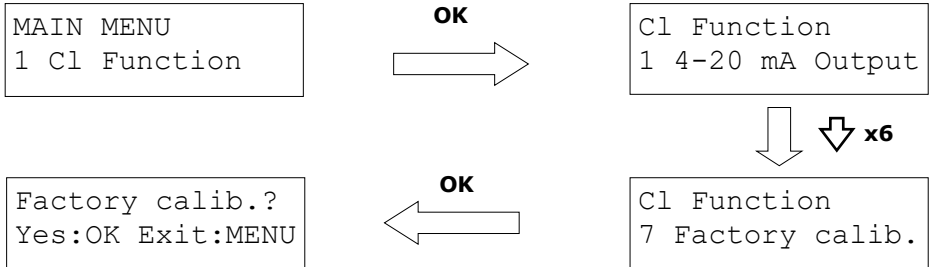

You can use this function to re-register the factory output calibration. Although chlorine probes need to be calibrated frequently in order to obtain accurate readings, this function can be useful in some situations and for diagnostics. If you press **OK**, the following screen will be displayed for a few seconds:

FACTORY CL
CALIBRATION OK

5.1.8 Chlorine function – Dosing time alarm

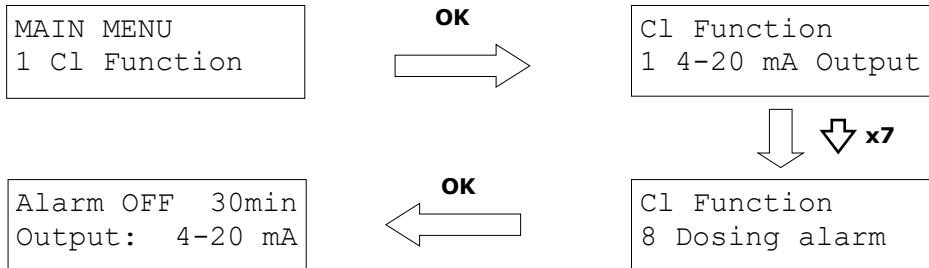

The chlorine dosing time alarm enables an alarm to be triggered that stops dosing if the time elapsed without the programmed setpoint being reached exceeds a certain limit. This can be useful for preventing overdosing, signalling a lack of product in the drum, or detecting possible probe or injection problems.

Place the cursor (**MENU** key) under the word *OFF* and use the arrows to activate (*ON*) or deactivate (*OFF*) the alarm.

Place the cursor next to the *min* reading and use the arrows to set the maximum dosing time in minutes.

Position the cursor to the right of *Output* and select with the arrows the output whose dosing time you want to limit.

Press **OK** to confirm and save.

If the maximum dosing time established for a parameter (chlorine, pH or both) is reached, the dosing **will be interrupted on all outputs of that parameter** and the following screens will alternate:

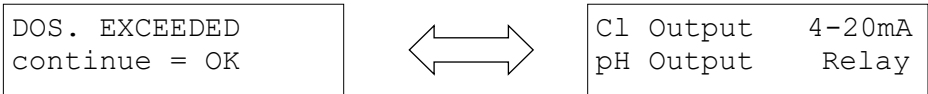

The screen on the right indicates the parameter(s) and the respective output at which the dosing time limit has been reached.

Click **OK** to continue. The timer(s) will reset and dosing will continue as normal.

5.2 pH FUNCTION

Cl	0.84 ppm
pH	7.50



MAIN MENU
1 Cl Function

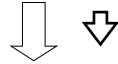

MAIN MENU
2 pH Function

All functions and settings related to pH measurement are found within **MAIN MENU 2 - pH function** and its different sub-menus:

5.2.1, 5.2.2, 5.2.3, 5.2.4 pH Function—pH control outputs

The pH function has control outputs similar to those of the chlorine function and its configuration is similar. The only difference is the direction of the dosage with respect to the setpoints:

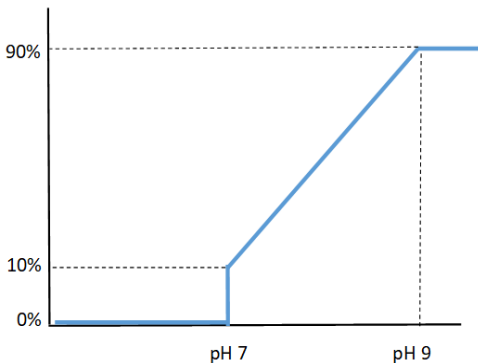

pH = 7.00	10%
pH > 9.00	90%

- When the pH is below the lower setpoint (pH 7.00 in the figure), the output will be maintained at 0%.

- When the pH is between the two points, the output will be a proportional value defined by both percentages. For example, in the case of the figure, if the pH is 8.00, the output will be equal to 50%.

- When the pH is above the upper setpoint (pH 9.00 in the figure), the output will be constant and equal to the dosage defined for that point: 90% in the figure.

See points **5.1.1** to **5.1.4**. for details on the outputs set-up.

5.2.5 pH function—pH4 calibration

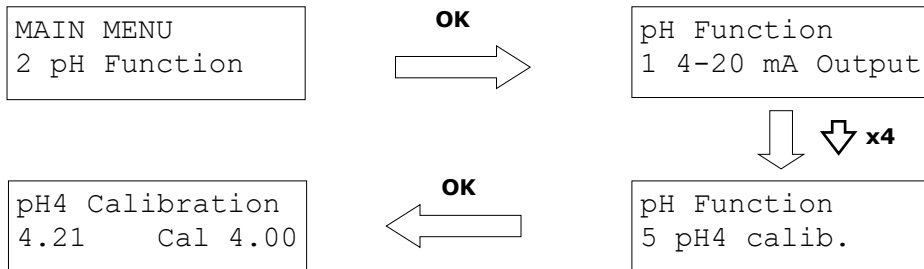

Enter the **5 Calib. pH 4** sub-menu and press **OK**. The lower left screen in the figure will appear. The value on the left shows the pH amount measured by the probe. The amount to the right of *Cal* indicates the pH of the calibration solution that must be adjusted, using the arrows, in order to suit the temperature and the solution used.

Dip the probe into the pH4 calibration solution, swirl the solution slightly with the probe and wait for a stable reading value to be reached.

Once the reading has stabilized, press the **OK** key to save the calibration or **MENU** to exit without saving the calibration. If you press **OK**, one of the following two screens will appear momentarily:

pH4 CALIBRATION
OK

pH4 CALIBRATION
ERROR

The screen on the left indicates that the calibration amounts entered are consistent and the calibration has been saved.

The screen on the right indicates that the probe response is too far from the amounts expected for the pH introduced and that calibration has not taken place.

5.2.6 pH function—pH7 calibration

Remove the probe from the pH4 solution, rinse its underside with clean water and gently shake it to remove excess water (do not rub the probe with a cloth or paper). Then go to the **6 Calib. pH7** menu and repeat the above process with the pH7 solution.

MAIN MENU
2 pH Function

OK

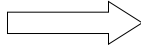

pH Function
1 4-20 mA Output

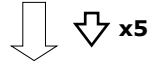

pH7 Calibration
7.23 Cal 7.00

OK

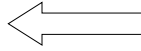

pH Function
6 pH7 calib.

5.2.7 pH Function – Factory calibration

MAIN MENU
2 pH Function

OK

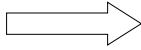

pH Function
1 4-20 mA Output

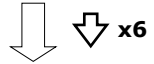

Factory calib.?
Yes:OK Exit:MENU

OK



pH Function
7 Factory calib.

Using this function, you can re-register the factory output calibration for the theoretical response of a new probe. This feature can be useful in some situations and for diagnostics or if you do not have calibration solutions. If you press **OK**, the following screen will be displayed for a few seconds:

FACTORY
CALIBRATION OK

5.2.8. pH function – Dosing time alarm

MAIN MENU
2 pH Function

OK

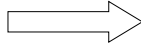

pH Function
1 4-20 mA Outut

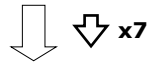

Alarm OFF 30min
Output: 4-20 mA

OK

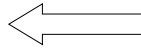

pH Function
8 Dosing alarm

The pH dosing time alarm enables an alarm to be triggered that stops dosing if the time elapsed without reaching the programmed setpoint exceeds a certain limit. This can be useful for pre-

venting overdosing, signalling a lack of product in the drum, or detecting possible probe or injection problems.

Place the cursor (**MENU** key) under the word *OFF* and use the arrows to activate (*ON*) or deactivate (*OFF*) the alarm.

Place the cursor next to the *min* reading and use the arrows to set the maximum dosing time in minutes.

Place the cursor to the right of *Output* and select with the arrows the output whose dosing time you want to limit.

Press **OK** to confirm and save.

If the maximum dosing time established for a parameter (chlorine, pH or both) is reached, the dosing will be interrupted in all outputs of that parameter and the following screens will alternate:

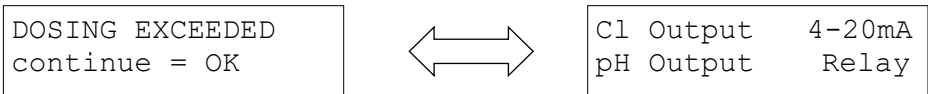

The screen on the right displays the parameter(s) and the respective output at which the dosing time limit has been reached.

Click **OK** to continue. The timer(s) will reset and dosing will continue normally.

5.3 INITIAL DOSING DELAY

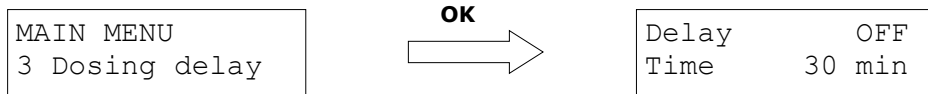

The probes take a certain amount of time to generate a valid response after being disconnected. This function allows you to set a delay after the appliance is powered, during which the dosing is stopped at all outputs and incorrect dosing is avoided. Remember that the controller must be powered at all times

Place the cursor under the word *OFF* (**MENU** key) and use the arrows to activate (*ON*) or deactivate (*OFF*) the delay. Place the cursor under the word *min* and use the arrows to set the desired delay time in minutes after the appliance is powered.

5.4 FLOW SENSOR

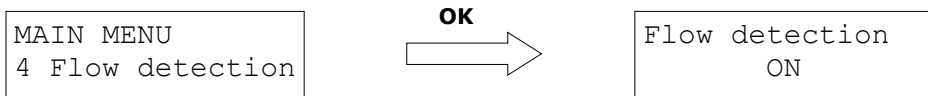

If the controller does not detect flow at the probe holder, probe readings are disabled and all dosing outputs are interrupted. This feature allows flow detection to be disabled and can be useful for maintenance and diagnostics. We recommend that, in normal operation, you always keep it on in order to avoid incorrect readings or improper dosing.

Choose *ON* or *OFF* with the help of the arrows to activate or deactivate the flow sensor. Then press **OK** to accept or **MENU** to exit.

5.5 LCD CONTRAST

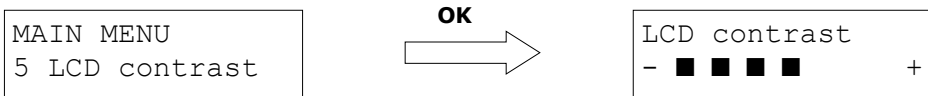

Adjust the contrast using the arrows and press **OK** to confirm or **MENU** to exit without saving.

5.6 RADIO TRANSMISSION CHANNEL

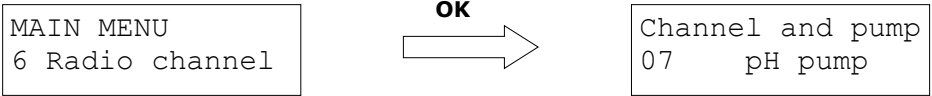

This screen displays the coding channel of the radio outputs and the transmission status. When transmission is taking place, the *TX* symbol flashes every second.

If there are several Innowater systems in the same installation, the controller and the connected devices of each system (wireless pumps, chlorinator) must have a different channel coding from the other existing systems so that each device only receives the orders from its Monitor controller.

To change the channel of the Monitor controller, go to the *6 Radio channel* menu, place the cursor under the channel number, select a new channel with the arrows (ignore the *Cl/pH pump* reading in this step) and press **OK**. The *TX* symbol will flash again, indicating that the controller is broadcasting on the new channel.

To change the channel of an Innowater chlorinator, go to the chlorinator's Radio channel menu and choose the same channel as the Monitor that will control it.

To change the radio channel of a pulse pump and connect it to the Monitor's chlorine or pH output:

1. Connect the pump power cord.
2. Trigger its level sensor (or short-circuit its input connector). Its data led will blink rapidly.
3. Go to the **6 Radio channel** menu of the Monitor, select the channel and choose *Ch Pump* or *pH Pump* to connect the pump to the chlorine output or to the pH output of the Monitor, respectively.
4. Press **OK**. The pump will receive a command to establish the new settings.
5. Turn off the pump's level input. The data reception LED will flash every second indicating that it is receiving data from the Monitor on the new channel. If the pump has been connected with **Radio 2 pH Output**, it will flash once every second. If the pump has been connected with **Radio 2 Chlorine Output**, it will flash quickly twice every second.



Before pressing **OK**, ensure that **only** the pumps in which you want to change the channel and/or connect the chlorine or pH output are powered and with the level input short-circuited. Otherwise, other pumps within range may inadvertently change their settings.

5.7 MODBUS

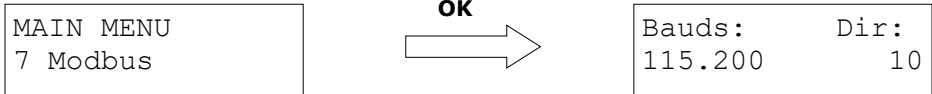

The Modbus protocol can be used through the RS485 port of the Monitor in order to obtain chlorine and pH levels and to change some settings. See [3.1 Control unit / Outputs connector](#) for connections details. To set the baud rate and the Monitor Modbus identifier (slave) go to Modbus menu 7.

The Monitor behaves as a slave in the Modbus protocol and responds to requests to read (function 0x04) or to write (function 0x06) of different parameters. The parameters are 2-byte wide being the first byte sent the most significant. If you are going to use this function, ask Innowater for the updated Modbus template.

Example of reading request (values in hexadecimal):

Modbus master request: 0A 04 00 0A 00 01 10 B3

0A	Monitor Modbus address
04	Read function
00 0A	Requested register (#10: ppmx100)
00 01	Number of requested registers (only 1 is allowed)
10 B3	CRC of previous bytes

Monitor reply: 0A 04 02 00 75 DD 16

0A	Monitor address
04	Read function
02	Number of remaining bytes
00 75	Chlorine reading in ppm x 100 (0x0075 = 117 = 1.17 ppm)
DD 16	CRC of previous bytes

Example of writing request (values in hexadecimal):

Modbus master request: 0A 06 00 20 00 14 89 74

0A	Monitor Modbus address
06	Write function
00 20	Requested register (32: lowest setpoint in ppmx100)
00 14	Value to be written (0x0014 = 20 = 0.2 ppm)
89 74	CRC of previous bytes

Monitor reply: 0A 06 00 20 00 14 89 74

0A	Monitor address
06	Write function
00 20	Number of remaining bytes
00 14	Chlorine reading in ppm x 100 (0x0075 = 117 = 1.17 ppm)
89 74	CRC of previous bytes

5.8 LANGUAGE

MAIN MENU
8 Language

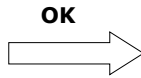

Choose language
English

Use the arrows to choose the language and confirm with **OK**.

6. WIRELESS PUMPS (OPTIONAL)

6.1 Wireless pulse pump

Innowater wireless pulse pumps are used with the **Radio 2 Outputs** of the chlorine and pH functions. These outputs send an ON/OFF signal modulated by a variable duty cycle (PWM) of 100 s that reflects the percentage of dosing calculated. See points 5.1.4 and 5.2.4 on programming Radio 2 outputs.

Packaging content:

- Pulse pump
- Inlet and output connectors
- Suction filter/level sensor with cable and BNC connector
- Injection valve
- Bracket and screws
- 4x6 rigid PP tube for injection
- 4x6 flexible PVC tube for suction

Description

- 1 Dosing product inlet
- 2 Dosing product outlet
- 3 Priming valve
- 4 Pulse frequency regulation
- 5 Reception and level blue LED indicator

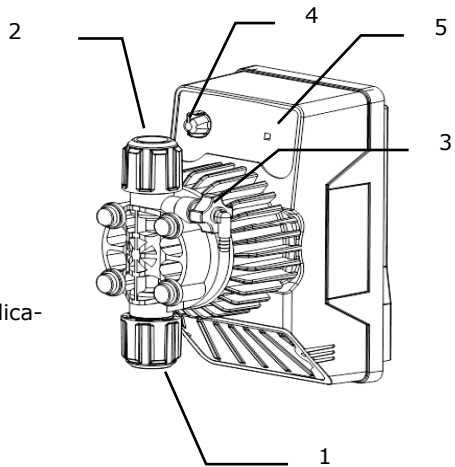

Operation

When connecting the pump to the network, and if it has been programmed with the same channel as its controller, the blue data reception led (5) will begin to flash, indicating that it is receiving data from the pump. If the pump has been set-up as a pH pump, it will flash once every second. If the pump has been set-up as a chlorine pump, it will flash twice every second. See the **Radio channel** section at the end of the chapter to set up the channel and the pump type. The pump has an input for the level sensor in its lower part through a BNC connector. The sensor signal is a voltage-free contact. When the float falls due to lack of liquid, the contact closes. If you do not want to use the sensor, just disconnect its cable from the pump. The data recep-

tion led (5) also acts as an indicator for the level sensor. If the level sensor is connected to the pump and it does not detect product (closed contact), the led (5) will flash quickly.

The control (4) enables the pulse frequency to be regulated in order to adapt the injection flow to the volume of the swimming pool. This regulation is independent of the setpoint programming. In general, if you need the pump to inject more product during an ON cycle, increase the pulse rate and vice versa.

Forced injection

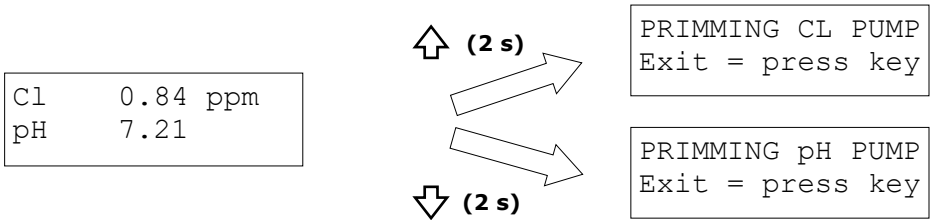

To force the ON state of the Radio 2 Outputs and activate the injection of the wireless pulse pump, go to the main screen of the controller and press the up arrow (Radio 2 Chlorine Output) or the down arrow (Radio 2 pH Output) for 2 seconds. The respective output will send the ON command while the screen on the right is displayed regardless of the output programming and the probe readings. Press any key to exit and stop the forced pulsation. If no key is pressed, after one minute the unit will automatically exit the forced pulsation mode.

Installation

Pump

Fix the pump to a wall using the supplied bracket. Before screwing it to the pump, use the bracket to mark the locations of the holes on the wall that you will need to drill. Choose a site close to the injection point. You can choose the location freely and at a distance from the controller since the pump does not require any connection to be wired to it. The power supply must be connected to a 230 VAC socket provided with a suitable **earth conductor** and protected by a **30-mA residual-current device**

Acid/Chlorine Drum

We strongly recommend that you do not place the product drum in the same room as the treatment plant. The vapours from it will cause any metallic feature or electronic equipment to rapidly deteriorate.

Injection circuit

The injection point should preferably be higher than the dosing pump and the product drum. Install the supplied valved injector in the circulation pipe just before the return to the swimming pool. If there is a salt water chlorinator, the acid injection should be done **after** the cell. Connect one end of the **rigid PE tube** (opaque) to the injector connector on the pipe. Connect the other end of the tube to the injection connector (2) of the pump.

Suction circuit

Connect one end of the transparent **flexible tube** to the suction connector (1) of the pump and the other end of the tube to the connector of the suction filter/level sensor. Connect the level sensor cable to the BNC connector on the bottom of the pump. Immerse the suction filter/level sensor in the acid drum and make sure it is standing upright and stable on the bottom. Close the drum as best you can to prevent the discharge of vapours.

Priming the pump

Once the pump, the product drum and the suction and injection tubes have been installed, proceed to prime the pump:

1. Prepare a tube and a container to collect the product through the prime valve (3) or channel the valve output to the acid or chlorine drum
2. Connect the pump to the network.
3. Open the pump prime valve (3).
4. Force the pump injection (see Forced injection).
5. Wait for the product to come out of the prime tube.
6. When you are sure the pump is completely filled with product, close the prime valve. The pump will start injecting through its injection tube.
7. Exit the forced pulsation mode.



If the product drum is far below the pump, the pump may not be able to suction the product. In that case, extract the acid using a syringe through the priming line until the acid comes out of it. **In general, we recommend to always use this method.**

Radio channel and connection of the pump to the chlorine or pH output.

To change the radio channel of a pulse pump and associate it to the **Radio 2 pH** or the **Radio 2 chlorine** outputs of the Monitor follow this steps:

1. Connect the pump power cord.
2. Activate the level sensor input (action the level sensor or short-circuit the input connector). The data blue LED on the pump will blink rapidly.
3. Go to **6 Radio channel** menu in the Monitor, select the channel and choose *pH Pump* or *Cl Pump* to connect the pump to the Radio 2 pH Output or the Radio 2 Ch Output of

the Monitor, respectively.

4. Press **OK**. The pump will receive a command to establish the new settings.

5. Turn off the pump's level input. The data reception LED will flash every second indicating that it is receiving data from the Monitor on the new channel. If the pump has been associated to the **Radio 2 pH Output**, the blue LED will flash once every second. If the pump has been associated to the **Radio 2 Chlorine Output** the blue LED will flash twice every second.



Before pressing **OK**, make sure that **only** the pumps in which you want to change the channel and/or associate to the chlorine or pH outputs are powered and with the level input activated. Otherwise, other pumps within the range may, inadvertently, change their settings.

7. MAINTENANCE

7.1 Filter

The probes require optimal filtering for their proper operation. Periodically check the condition of the filter. If necessary, unscrew the transparent glass, remove the filter and wash it by injecting water from the outside to the inside.

7.2 Probes

The probes need to be calibrated periodically for the correct operation of the system and each time conditions of use change: flow, temperature, conductivity. Check points 3.2, 5.4.4, 5.4.5, 5.5.3 and 5.5.4.

7.3 Open chlorine probe maintenance.

The open chlorine contains an electrolyte that must be replaced from time to time depending on the working conditions and the quality of the water. Follow the supplied probe instructions carefully. When removing the probe and reinserting it into its housing, be very careful not to exert any pressure on its membrane. For this purpose:

Interrupt the water flow in the probe holder by closing the flow regulation screw (5)

Carefully remove the cap above the flow meter or pH probe to bring the inner volume to atmospheric pressure.

Empty the probe holder by opening the sampling valve (3).

7.4 Priming the pumps

See chapter **6 Wireless Pumps**

8. TECHNICAL CHARACTERISTICS

Panel

Dimensions	500 x 500 mm
Material	Methacrylate

Probe holder

Dimensions	240 x 170 mm
Material	Methacrylate
Tubing	6x8 mm

Filter

Material	SAN
Cartridge	PET washable, 60 microns
Tubing	6x8 mm

Control unit

Weight	300 g
Dimensions	220 x 130 x 85 mm
Power supply	100-240 VAC, 50-60 Hz
Power consumption	20 W
pH scale	0–14 pH
pH scale precision	0.01 pH
pH calibration	Two points: pH4 and pH7
Chlorine scale	0 – 10 mg/l
Chlorine scale precision	0.01 mg/l
Chlorine calibration	Two points: Zero and slope

Control outputs

4-20 mA x2	With isolated power supply: 24VDC 1 W máx.
Relay x2	Dry contact: 2 A, 230 VAC max.
Pump output x2	Radio link

Dosing pump

Weight	1.5 Kg
Dimensions	170 x 145 x 95 mm
Power supply	230 VAC, 50-60 Hz
Power consumption	12 W
Fuse	2A T 5x20
Protection rating	IP65
Dosing flow	5 l/h a 8 bar
Max. pulse frequency	160 pulses/min
Materials	
Membrane	PTFE
Pump head	PVDF-T
Valve balls	Ceramic
Body	PVC
Enclosure	PP

Chlorine Cu/Pt probe

Measured variable	Free chlorine
Measuring range	0.1—5.0 mg/l
pH dependency	Strong
Max. pressure	3 bar
Optimum flow rate	30 l/h
Requested filtration	0.5 mm max.

